

DIGI PLEX EVO

Access Control Module V4.2



ACM12

Installation Instructions



paradox.com
Printed in Canada 05/2014 ACM12-EI02

Introduction

The Access Control Module (ACM12) is designed to be used with the DigiPlex EVO System control panels. Each ACM12 allows you to connect a reader, a REX device, a door contact and a locking device to control the access to one door. If desired, door contacts can also be assigned to zones in the control panel to link the doors to the alarm system. This will allow you to use the same door for the access control system and the alarm system.

What's New 4.2

- Support for six additional schedule intervals for Door Unlock Schedule.
- Added security when disarming your system. New option to disarm with access card and PIN code.

Technical Specifications

AC Power:	16Vac, 20/40VA, 50 - 60Hz
Aux. Power:	12Vdc, typical 600mA, 1A max.
Battery:	12Vdc, 4Ah minimum
No. of Outputs:	2; one 50mA PGM output, one form C relay rated at 5A/28Vdc, N.O./N.C.
No. of Zones:	2 (Door Contact & REX device)
No. of Inputs:	2 (Negative Trigger & Tamper inputs)
Control Panel Compatibility:	Any EVO control panel

Installation

The module is connected to the control panel's combus as shown in Figure 1. Please refer to the control panel's Programming Guide for the maximum installation distance. Devices connected to the PGM output must be connected as shown in Figure 2. Refer to Figure 5 for connection drawings for the REX device, reader, locking device and door contact.

⚠ The door contact follows the control panel's EOL definition. When EOL is enabled and the door contact is not used, place a 1kΩ resistor across the CT and AUX- input terminals. If EOL is disabled, use a jumper. If the REX device is not used, place a jumper across the REX and AUX- terminals.

AC Power

Use a 16.5Vac (50/60 Hz) transformer with a minimum 20VA. as shown in Figure 1. Do not use any switch-controlled outlets to power the transformer.

Backup Battery

To power the module's door lock relay during a power failure, connect a 12Vdc 4Ah rechargeable acid/lead or gell cell backup battery as shown in Figure 1. Connect the battery after applying AC power.

⚠ Inverting the polarity when installing the battery will blow the battery fuse.

Connecting the External Negative Trigger

The ACM12 comes with an external negative trigger. You can use a PGM from the control panel or another module to release the access control door lock. The external negative trigger can also be triggered using a push-button. When the push button is pressed, the door will unlock. The PGM or push-button must ground the negative trigger. Connect the push-button as shown in Figure 2.

LED Display

AC (Green):	On when receiving AC power.
BATT (Green):	On when charging and during battery tests.
AUX (Yellow):	On when auxiliary output is active.
ERROR (Red):	Indicates a problem with the module.
RX (Green):	Flashes when receiving information from the panel.
TX (Green):	Flashes when transmitting information to the panel.

Table 1: Special Display

Error	RX	TX	Condition
ON	OFF	OFF	Combus is shorted / No clock / No data
ON	OFF	ON	Wrong data / Invalid Combus address (Too many modules)
ON	ON	OFF	Future Use
ON	ON	ON	Combus lines reversed (YEL and GRN)
Flash	----	----	Combus power is too low

Connection Diagrams

Figure 1: Connecting the power and combus

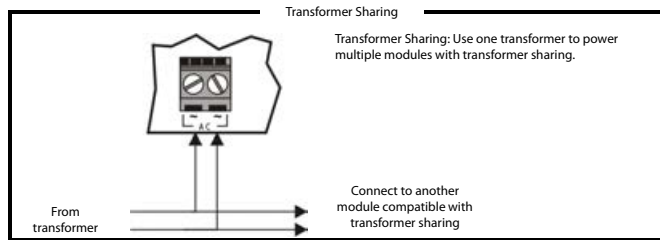
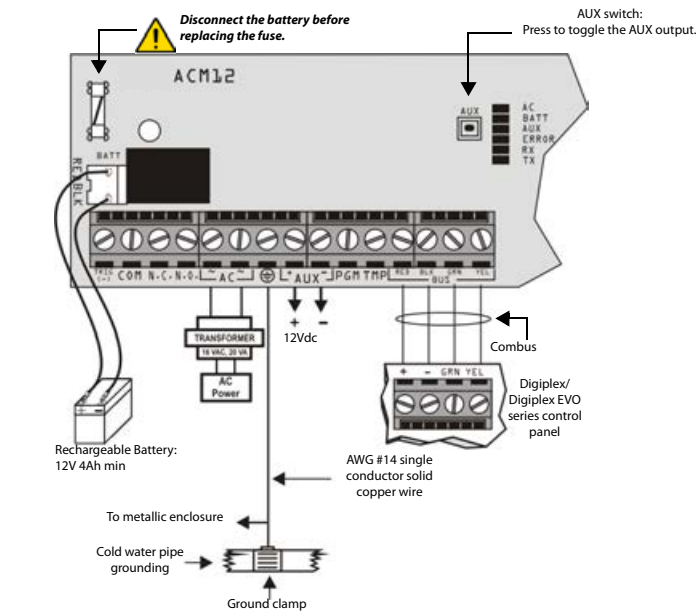

Figure 2: Additional Connection Information

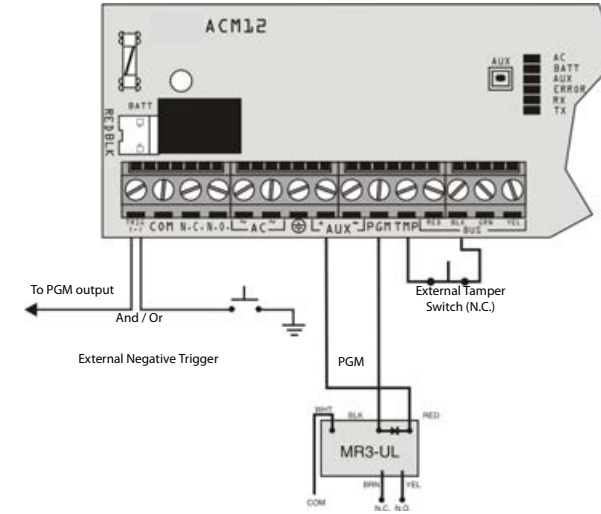

Figure 3: Connecting a 4-Wire Reader (R910 / R915)

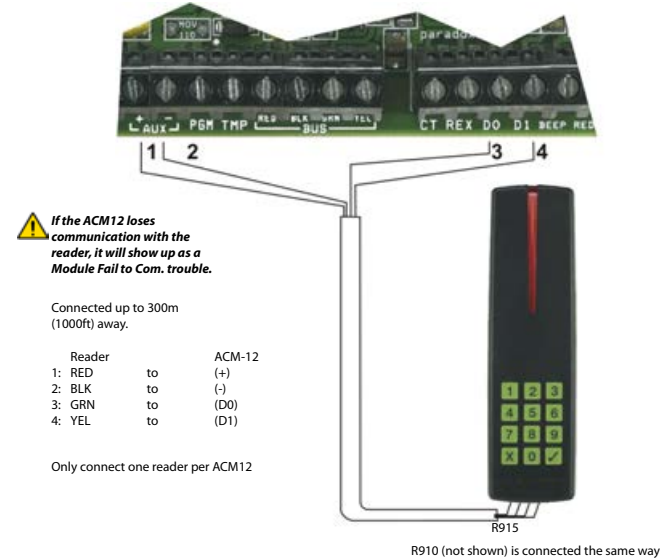

Figure 4: Connecting a 7-Wire Routing Cable

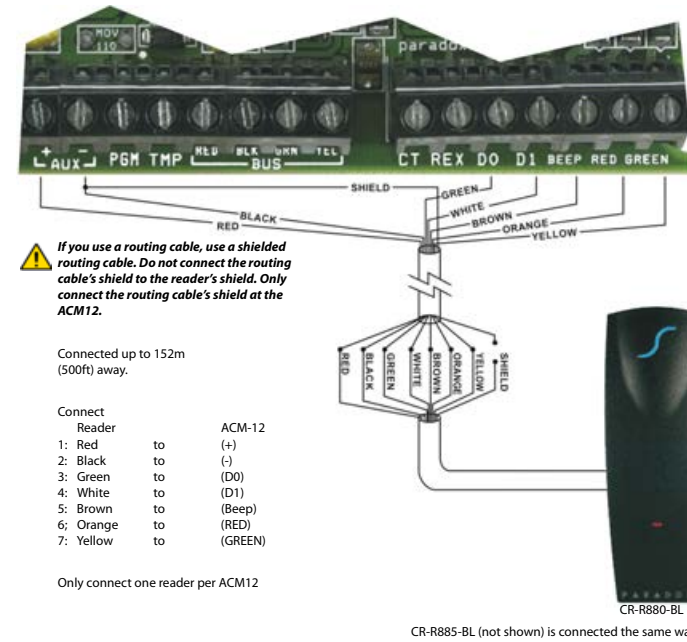

Figure 5: Connecting Access Control Devices

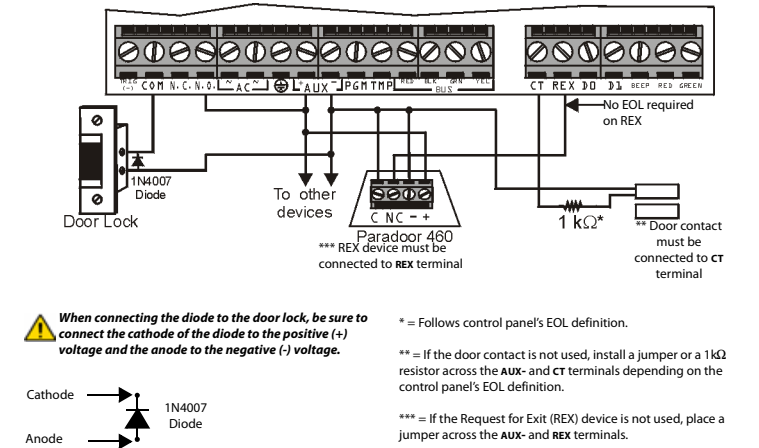
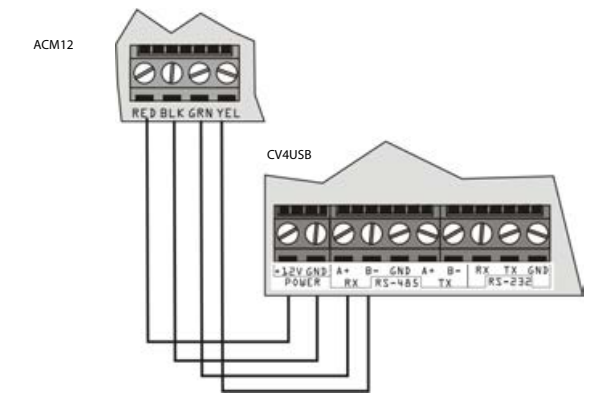

Figure 6: Connecting for Firmware Upgrade (CONV4USB)



△ = Default setting

SECTION [001]: Partition Assignment

Option	OFF	ON
[1] Partition 1	<input type="checkbox"/> Disabled	△ Enabled
[2] Partition 2	<input type="checkbox"/> Disabled	△ Enabled
[3] Partition 3	<input type="checkbox"/> Disabled	△ Enabled
[4] Partition 4	<input type="checkbox"/> Disabled	△ Enabled
[5] Partition 5	<input type="checkbox"/> Disabled	△ Enabled
[6] Partition 6	<input type="checkbox"/> Disabled	△ Enabled
[7] Partition 7	<input type="checkbox"/> Disabled	△ Enabled
[8] Partition 8	<input type="checkbox"/> Disabled	△ Enabled

SECTION [002]: General Options 1

Option	OFF	ON
[1] Tamper Input	△ Disabled	<input type="checkbox"/> Enabled
[2] Battery Charging Current	△ 350mA	<input type="checkbox"/> 850mA
[3] Reader's red LED to follow partition's status	<input type="checkbox"/> Disabled	△ Enabled
[4] Reader's beeping to follow partition's status when option [3] is ON	<input type="checkbox"/> Disabled	△ Enabled
[5] Card activates door unlocked schedule	<input type="checkbox"/> Disabled	△ Enabled
[6] Door will relock	△ Immediately	<input type="checkbox"/> When closed
[7] Reader's green LED for Access Granted	<input type="checkbox"/> Disabled	△ Enabled
[8] Unlock on Request for Exit (REX)	<input type="checkbox"/> Disabled	△ Enabled

SECTION [022]: Safe Mode Options

Option	OFF	ON
[1] Safe Mode	<input type="checkbox"/> Disabled	△ Enabled
[2] Safe Mode Access	<input type="checkbox"/> Disabled	△ Enabled
[3] Reader Safe Mode Feedback	△ Visual	<input type="checkbox"/> Visual & audible
[4] Unlock Door in Safe Mode	△ Disabled	<input type="checkbox"/> Enabled
[5] Access Cards in Safe Mode	△ Safe Cards only	<input type="checkbox"/> Any Cards
[6] to [8] Future Use	<input type="checkbox"/> N/A	<input type="checkbox"/> N/A

SECTION [031] PGM Options 2

Option	OFF	ON
[1] Flexible PGM Deactivation Option	△ PGM Timer only	<input type="checkbox"/> Timer / Deactivation event
[2] Reload Timer on Activation Event	△ Don't Reload	<input type="checkbox"/> Reload Timer
[3] to [4] Future Use	<input type="checkbox"/> N/A	<input type="checkbox"/> N/A
[5] Card and Pin required to disarm*	△ OFF	<input type="checkbox"/> ON
[7] to [8] Future use	<input type="checkbox"/> N/A	<input type="checkbox"/> N/A

* Only valid when section [004] options 4 and 5 are enabled.

SECTION [003]: General Options 2

Option	OFF	ON
[1] Door Left Open Alarm	△ Disabled	<input type="checkbox"/> Enabled
[2] Door Left Open Pre-alarm	<input type="checkbox"/> Disabled	△ Enabled
[3] Door Left Open Alarm	<input type="checkbox"/> Silent	△ Audible
[4] Door Left Open Alarm follows	△ Alarm Restore	<input type="checkbox"/> Beep Timer
[5] Door Forced Open Alarm	△ Disabled	<input type="checkbox"/> Enabled
[6] Door Forced Alarm	<input type="checkbox"/> Silent	△ Audible
[7] Door Forced Alarm follows	△ Alarm Restore	<input type="checkbox"/> Beep Timer
[8] Reader Access Feedback	<input type="checkbox"/> Visual	△ Visual & audible

SECTION [004]: PGM Options

Option	OFF	ON
[1] PGM Deactivation After	△ Deactivation Event	<input type="checkbox"/> PGM Timer
[2] PGM Normal State	△ N.O.	<input type="checkbox"/> N.C.
[3] PGM Base Time	△ 1 second	<input type="checkbox"/> 1 minute
[4] & [5] Special	[4] [5]	[4] [5]
[6] Reader Locate Feedback	△ Visual	<input type="checkbox"/> Visual & audible
[7] Unlock Door on Fire Alarm	△ Disabled	<input type="checkbox"/> Enabled
[8] AC and Battery Supervision	△ Enabled	<input type="checkbox"/> Disabled

Section	Data	Description	Default
[005]	__/__/__ (000 to 255 x 1 minute; 000 = Instant)	AC failure report delay	030
[006]	__/__/__ (001 to 255 seconds)	Door Unlocked Period	005
[007]	__/__/__ (001 to 255 seconds added to section [006])	Door Unlocked Period extension	015
[008]	__/__/__ (001 to 255 seconds)	Door Left Open Interval	060
[009]	__/__/__ (001 to 255 seconds) Time to start pre-alarm before alarm is triggered	Door Left Open Pre-Alarm Timer	015
[010]	__/__/__ (001 to 255 seconds)	Beep timer for Door Left Open Alarm	005
[011]	__/__/__ (001 to 255 seconds)	Beep timer for Door Forced Open alarm	005
[012]	__/__/__ (000 to 255; refer to option [3] in section [004])	PGM timer	005
[013]	Door unlock schedule		

	Start Time	End Time	S	M	T	W	T	F	S	H
Schedule A:	____:____	____:____	1	2	3	4	5	6	7	8
Schedule B:	____:____	____:____	1	2	3	4	5	6	7	8
Schedule C:	____:____	____:____	1	2	3	4	5	6	7	8
Schedule D:	____:____	____:____	1	2	3	4	5	6	7	8
Schedule E:	____:____	____:____	1	2	3	4	5	6	7	8
Schedule F:	____:____	____:____	1	2	3	4	5	6	7	8
Schedule G:	____:____	____:____	1	2	3	4	5	6	7	8
Schedule H:	____:____	____:____	1	2	3	4	5	6	7	8

Section	Data	Description	Default
[023]	__/__/__ (001 to 024 hours; 000 = Disabled)	Safe Mode Door Unlocked Period	000
[024]	__/__/__ (001 to 255 seconds; 000 = Follow REX)	REX Unlocked Period	000
[025]	__/__/__ (000 to 003)	Red LED Brightness	003
[026]	__/__/__ (000 to 003)	Green LED Brightness	003
[027]	__/__/__ (000 to 003)	Buzzer Frequency	001
[028]	__/__/__ (000 to 255 minutes; 000 = instant)	AC Restore Report Delay	005
[029]	__/__/__ (000 to 255 minutes)	Stay Lock Delay	000
[030]		Test PGM: Activates the PGM for 8 seconds to verify if the PGM is functioning properly.	
[032]	__/__/__ (000 = steady, 001 to 254 = pulsed (increments of 8ms), 255 = pulsed fire)	PGM Output type	000
[033]	__/__/__ (000 to 255 seconds)	Bypass door force alarm delay	000
[040]		Access Card Serial Number Display: View an access card's serial number displayed on any LCD or Grafica keypad on the combus. When the ACM12 is in access card display mode, the door connected to the module cannot be accessed.	
[061]		Assign Safe Mode Access Card 1 (Present Card 3 Times)	
[062]		Assign Safe Mode Access Card 2 (Present Card 3 Times)	
[063]		Assign Safe Mode Access Card 3 (Present Card 3 Times)	
[064]		Assign Safe Mode Access Card 4 (Present Card 3 Times)	
[070]		Delete All Safe Mode Access Cards	
[071]		Delete Safe Mode Access Card 1	
[072]		Delete Safe Mode Access Card 2	
[073]		Delete Safe Mode Access Card 3	
[074]		Delete Safe Mode Access Card 4	

Warranty

For complete warranty information on this product please refer to the Limited Warranty Statement found on the website [www.paradox.com/terms](http://paradox.com/terms). Your use of the Paradox product signifies your acceptance of all warranty terms and conditions.

We strongly advise that you review and take into consideration the "Limitations of Alarm Systems" document available on our website at <http://paradox.com/Terms/>.

© 2003-2014 Paradox Security Systems Ltd. All rights reserved. Specifications may change without prior notice. One or more of the following US patents may apply: 7046142, 6215399, 6111256, 6104319, 5920259, 5886632, 5721542, 5287111, 5119069, 5077549 and RE39406 and other pending patents may apply. Canadian and international patents may also apply.

Digiplex EVO is a trademark or registered trademark of Paradox Security Systems Ltd. or its affiliates in Canada, the United States and/or other countries.

Technical Support

For technical support in Canada or the U.S., call 1-800-791-1919, Monday to Friday from 8:00 a.m. to 8:00 p.m. EST. For technical support outside Canada and the U.S., call 00-1-450-491-7444, Monday to Friday from 8:00 a.m. to 8:00 p.m. EST. Please feel free to visit our website at www.paradox.com.

	Event Group	Feature Group	Start #	End #
	Section	Section	Section	Section
PGM Activation	[014] __/__/__	[015] __/__/__	[016] __/__/__	[017] __/__/__
PGM Deactivation	[018] __/__/__	[019] __/__/__	[020] __/__/__	[021] __/__/__

⚠ Only Event Groups 000 to 055, 062 and 063 can be used to program the module's PGM.